

HC997

made in italy



DESCRIZIONE/DESCRIPTION

Pompa dosatrice elettromagnetica multi-funzione con dosaggio costante e proporzionale. Versatile e completamente programmabile per soddisfare ogni applicazione.

- Contenitore in PBT ad alta resistenza adatto per alte temperature (ambienti e liquidi);
- Ingresso per sonda di livello;
- Regolazione digitale della frequenza degli impulsi 0-100%;
- Alimentazione: 220VAC - 50/60Hz. A richiesta: 110V;
- Interruttore On-Off;
- Protezione IP65;
- Interfaccia digitale con cinque tasti e display LCD 2x16 retroilluminato;
- Valvola di adescamento manuale;
- Montaggio a parete o a basamento (staffe incluse nel kit).

Multifunction solenoid driven dosing pump with constant and proportional dosing. Versatile and fully programmable suitable for any application.

- High impact PBT housing suitable for high temperature environments and fluids;
- Level probe input;
- Digital injection frequency setting 0-100%;
- Power supply: 220VAC - 50/60Hz. Upon request: 110V;
- On-Off switch;
- IP65 protection;
- Digital control and settings by five keys and LCD display backlight 2x16;
- Manual air bleed valve for quick priming;
- Ready for wall or foot mounting at installation site (brackets included).



CARATTERISTICHE TECNICHE/TECHNICAL FEATURES

	Versione standard Standard version	A richiesta Upon request
Corpo pompa <i>Pump head</i>	PVDF	-
Cassa pompa <i>Pump housing</i>	PBT	-
Diaframma <i>Diaphragm</i>	PTFE	-
Sfere <i>Balls</i>	PTFE	Pyrex/ceramica <i>Pyrex/ceramic</i>
Valvole <i>Body valve</i>	PVDF	-
O-rings <i>O-rings</i>	Viton*	Dutral*
Valvola di iniezione molla - sfera <i>Spring loaded injection valve</i>	Hastelloy-PTFE	Hastelloy-PTFE/ Hastelloy-ceramica <i>Hastelloy-PTFE/Hastelloy-ceramic</i>
Raccordo d'iniezione <i>Injection fitting</i>	PVDF	-
Valvola di fondo <i>Foot valve</i>	PVDF	-
Alimentazione <i>Power supply</i>	230V	110V



DIMENSIONI/DIMENSIONS

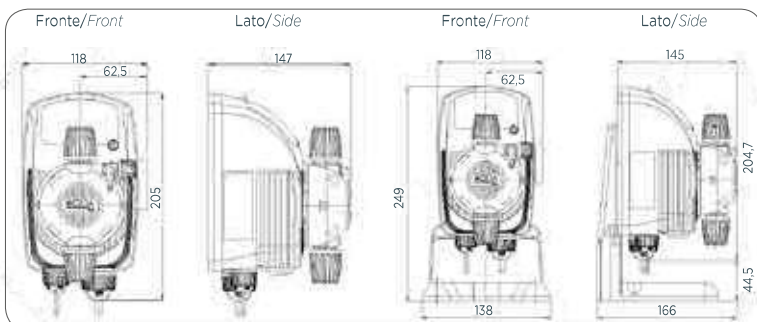

NORMATIVE/STANDARDS

- n° 2004/108/CE Direttiva EMC
- n° 2006/95/CE "DBT Low Voltage Directive"
- n° 2011/65/UE, 2012/19/UE "direttive RoHs e WEEE"
- no. 2004/108/CE EMC directive
- no. 2006/95/CE "DBT Low Voltage Directive"
- no. 2011/65/UE, 2012/19/UE "RoHs and WEEE directives"



IMBALLO/PACK

- Confezione singola/Single pack:
axbxc: 192x160x250 mm
Kg: 2,86
- Confezione multipla/Multipack:
6pz/pcs-axbxc:405x270x515mm
Kg: 18,16

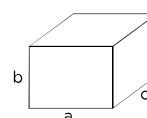

01 > pompe dosatrici elettromagnetiche solenoid driven dosing pumps

HC997 Modello/Model A

- Costante: portata, tempo, quantità da dosare, ciclico;
- Proporzionale: 0/4-20mA, ppm, 1xN, 1:N, 1xN(M) Ist, 1xN(M);
- Modo Timer: giornaliero o settimanale;
- Allarmi: livello, flusso;
- Buzzer;
- Impostazione Relè;
- Orologio e data;
- Statistiche.

- Constant: flow-rate, time, dosing quantity, cyclic;
- Proportional: 0/4-20mA, ppm, 1xN, 1:N, 1xN(M) Ist, 1xN(M);
- Timer mode: daily o weekly;
- Alarms: level, flux;
- Buzzer;
- Relay settings;
- Clock and data;
- Statistics.

Codice Code	Modello Model	Portata Flow rate	Pressione Pressure	N°colpi Strokes	Vol. iniezione Stroke volume	Assorbimento Consumption	Tubi (INTxEST) Tubing IDxOD	Corpo pompa Pump head
		lt/h	BAR	BPM/SPM	ml/colpo	watt	mm	
AD97100010000	1	2	8	150	0,22	18	4x6	PVDF 1/2"
		5	5		0,55			
		7	2		0,77			
AD97101010000	2	7	4	150	0,77	18	4x6	PVDF 1/2"
		8	2		0,88			
		10	0		1,11			
AD97102010000	3	3	12	150	0,33	22	4x6	PVDF 1/2"
		4	10		0,44			
		5	8		0,55			
AD97103010000	4	10	4	180	0,93	22	4x6	PVDF 1/2"
		12	2		1,11			
		14	0		1,29			
AD97107010000	5	2	20	75	0,44	22	4x6	PVDF 1/2"
		2,5	18		0,56			
		3	15		0,67			

HC997 Modello/Model B

- Costante: portata, tempo, quantità da dosare, ciclico;
- Proporzionale: 0/4-20mA, ppm, 1xN, 1:N, 1xN(M) Ist, 1xN(M);
- Modo Timer: giornaliero o settimanale;
- Ingresso pH o Rx (Orp) per dosaggio proporzionale;
- Allarmi: livello, flusso;
- Buzzer;
- Impostazione Relè;
- Orologio e data;
- Statistiche.

- Constant: flow-rate, time, dosing quantity, cyclic;
- Proportional: 0/4-20mA, ppm, 1xN, 1:N, 1xN(M) Ist, 1xN(M);
- Timer mode: daily o weekly;
- pH or Rx (Orp) input for proportional dosing;
- Alarms: level, flux;
- Buzzer;
- Relay settings;
- Clock and data;
- Statistics.

Codice Code	Modello Model	Portata Flow rate	Pressione Pressure	N°colpi Strokes	Vol. iniezione Stroke volume	Assorbimento Consumption	Tubi (INTxEST) Tubing IDxOD	Corpo pompa Pump head
		lt/h	BAR	BPM/SPM	ml/colpo	watt	mm	
AD97200010000	1	2	8	150	0,22	18	4x6	PVDF 1/2"
		5	5		0,55			
		7	2		0,77			
AD97201010000	2	7	4	150	0,77	18	4x6	PVDF 1/2"
		8	2		0,88			
		10	0		1,11			
AD97202010000	3	3	12	150	0,33	22	4x6	PVDF 1/2"
		4	10		0,44			
		5	8		0,55			
AD97203010000	4	10	4	180	0,93	22	4x6	PVDF 1/2"
		12	2		1,11			
		14	0		1,29			
AD97207010000	5	2	20	75	0,44	22	4x6	PVDF 1/2"
		2,5	18		0,56			
		3	15		0,67			

HC997 Modello/Model C

- Costante: portata, tempo, quantità da dosare, ciclico;
- Proporzionale: 0/4-20mA, ppm, 1xN, 1:N, 1xN(M) Ist, 1xN(M);
- Modo Timer: giornaliero o settimanale;
- Misura e controllo del cloro (sonda pt-cu) e dosaggio proporzionale;
- Allarmi: livello, flusso;
- Buzzer;
- Impostazione Relè;
- Orologio e data;
- Statistiche.

- Constant: flow-rate, time, dosing quantity, cyclic;
- Proportional: 0/4-20mA, ppm, 1xN, 1:N, 1xN(M) Ist, 1xN(M);
- Timer mode: daily o weekly;
- Proportional and measure of Chloro (pt-cu probe) and proportional dosing;
- Alarms: level, flux;
- Buzzer;
- Relay settings;
- Clock and data;
- Statistics.

Codice Code	Modello Model	Portata Flow rate	Pressione Pressure	N°colpi Strokes	Vol. iniezione Stroke volume	Assorbimento Consumption	Tubi (INTxEST) Tubing IDxOD	Corpo pompa Pump head
		lt/h	BAR	BPM/SPM	ml/colpo	watt	mm	
AD97300010000	1	2	8	150	0,22	18	4x6	PVDF 1/2"
		5	5		0,55			
		7	2		0,77			
AD97301010000	2	7	4	150	0,77	18	4x6	PVDF 1/2"
		8	2		0,88			
		10	0		1,11			
AD97302010000	3	3	12	150	0,33	22	4x6	PVDF 1/2"
		4	10		0,44			
		5	8		0,55			
AD97303010000	4	10	4	180	0,93	22	4x6	PVDF 1/2"
		12	2		1,11			
		14	0		1,29			
AD97307010000	5	2	20	75	0,44	22	4x6	PVDF 1/2"
		2,5	18		0,56			
		3	15		0,67			

01 > pompe dosatrici elettromagnetiche solenoid driven dosing pumps







HC997 Modello/Model D

- Costante: portata, tempo, quantità da dosare, ciclico;
- Proporzionale: 0/4-20mA, ppm, 1xN, 1:N, 1xN(M) Ist, 1xN(M);
- Modo Timer: giornaliero o settimanale;
- Misura con sonde A-J e dosaggio proporzionale;
- Allarmi: livello, flusso;
- Buzzer;
- Impostazione Relè;
- Orologio e data;
- Statistiche.

- Constant: flow-rate, time, dosing quantity, cyclic;
- Proportional: 0/4-20mA, ppm, 1xN, 1:N, 1xN(M) Ist, 1xN(M);
- Timer mode: daily o weekly;
- Measure by A-J probe and proportional dosing;
- Alarms: level, flux;
- Buzzer;
- Relay settings;
- Clock and data;
- Statistics.







Codice Code	Modello Model	Portata Flow rate	Pressione Pressure	N°colpi Strokes	Vol. iniezione Stroke volume	Assorbimento Consumption	Tubi (INTxEST) Tubing IDxOD	Corpo pompa Pump head
		lt/h	BAR	BPM/SPM	ml/colpo	watt	mm	
AD97400010000	1	2	8	150	0,22	18	4x6	PVDF 1/2"
		5	5		0,55			
		7	2		0,77			
AD97401010000	2	7	4	150	0,77	18	4x6	PVDF 1/2"
		8	2		0,88			
		10	0		1,11			
AD97402010000	3	3	12	150	0,33	22	4x6	PVDF 1/2"
		4	10		0,44			
		5	8		0,55			
AD97403010000	4	10	4	180	0,93	22	4x6	PVDF 1/2"
		12	2		1,11			
		14	0		1,29			
AD97407010000	5	2	20	75	0,44	22	4x6	PVDF 1/2"
		2,5	18		0,56			
		3	15		0,67			

KIT DI INSTALLAZIONE/INSTALLATION KIT

Codice Code	Modello Model
 ADSP6000078	PE tubo mandata (2m) PE delivery tube (2m)
 ADSP6000546	PVC crystal tubo (aspirazione + spurgo) (2 m) PVC crystal tube(suction + bleed) (2 m)
 ADSP6000028	Filtro di fondo PVDF 4x6 Foot filter PVDF 4x6
 ADSP6200031	Valvola di iniezione a sfera 1/2" PVDF 4x6 Injection valve ball 1/2" PVDF 4x6
 ADSP6020221	Staffa di fissaggio a parete (HC100-150-151-897-997-999) Wall fixing bracket (HC100-150-151-897-997-999)
 ADBAS100	Base di sostegno (HC150-151-897-997-999) Horizontal mounting bracket (HC150-151-897-997-999)
 ADSP6000041	Tasselli e viti Anchors and screws

ACCESSORI E RICAMBI/ACCESSORIES AND SPARE PARTS

Accessori/Accessories

Codice Code	Modello Model					
 ADSLG	Sonda livello con HIRSHMANN Level probe with HIRSHMANN					
Codice Code	Modello Model	Tenute Seals	Altezza Height mm	Connettore Connector	Connessioni Connections	Sebatoio Tanks It
 ADLASM10C0	Lancia di aspirazione Suction device	GL - VT	115 - 600	con with HIRSH	4x6	60 - 100
 ADLASM30C0	Lancia di aspirazione Suction device	GL - VT	115 - 840	con with HIRSH	4x6	200 - 300
Codice Code	Modello Model	Dimensione Size Øxh	Volume Volume It			
 ADTANK010	Serbatoio polietilene PE tank	500 x 680	100			
 ADTANK020	Serbatoio polietilene PE tank	620 x 800	200			
 ADTANK030	Serbatoio polietilene PE tank	710 x 890	300			